

Operating Instructions

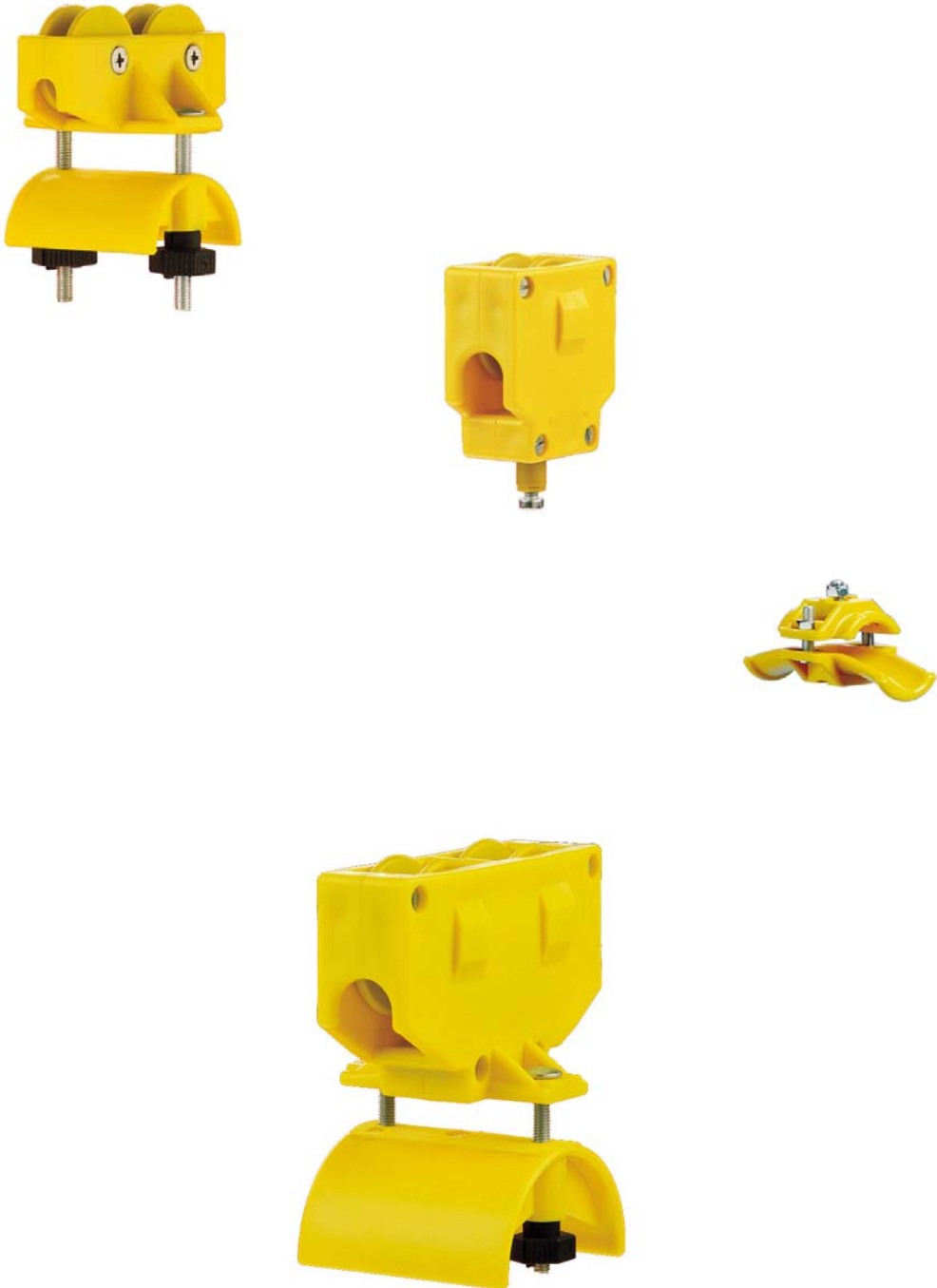

Festoon Systems for Steel Ropes Program 0210 / 0215

BAL0200-0004-E



Contents

	Page
1	Target audience for operating instructions 5
2	General information 5
2.1	General safety information 5
2.2	Information on operating instructions 6
2.3	Applicable documents 6
2.4	Limitation of liability 6
2.5	Copyright 7
2.6	Spare parts 7
2.7	Disposal 7
3	Safety 8
3.1	Intended use 8
3.2	Content of the operating instructions 9
3.3	Changes and modifications to the machine 9
3.4	Operator responsibility 9
3.5	Requirements on the personnel 10
3.6	Personal protective equipment 11
3.7	Hazards posed by product 11
4	Construction 13
5	Transport, packaging and storage 14
5.1	Safety instructions 14
5.2	Transport inspection 14
5.3	Packaging 15
5.4	Storage 15

Festoon Systems for Steel Ropes Program 0210 / 0215

BAL0200-0004-E

6	Installation.....	16
6.1	Safety instructions	16
6.2	Steel rope fixation	16
6.2.1	General information.....	16
6.2.2	Steel rope fixation with 2 tensioning screws	17
6.2.3	Steel rope fixing with tensioning screws, roller trestle and counterweight.....	19
6.3	Assembly of the cables trolleys 021111, 021112, 021115 and 021116	20
6.4	Laying of cables	21
6.4.1	Laying of round cables.....	21
6.4.2	Arrangement of flat cables	22
6.5	Flat cable clamps	23
6.6	Cable trolleys with plastic support and split nuts	24
7	Commissioning the festoon system.....	25
7.1	Inspections on deactivated system	25
7.2	Inspections on running systems	26
8	Operation	27
9	Faults - causes and solution	28
10	Maintenance	29
10.1	Inspection	30
10.1.1	Inspection on deactivated system	30
10.1.2	Inspection of towing ropes and criteria for replacement	31
10.1.3	Inspection on moving system	32
10.2	Service	33
10.3	Repeat inspections	35
10.4	Repair.....	35

Operating Instructions



Festoon Systems for Steel Ropes Program 0210 / 0215

BAL0200-0004-E

11	Spare parts	36
12	Product observations.....	37
13	Appendix.....	39
13.1	Final handover document	39

1 Target audience for operating instructions

The operating instructions are intended for qualified specialists who install the festoon systems, operate them and who are familiar with the requirements regarding work safety and accident prevention.

2 General information

2.1 General safety information

Safety and hazard information: Safety and hazard information is identified in these operating instructions by symbols. Signal words are used to indicate the degree of hazard. Always observe safety and hazard information and work carefully to avoid accidents, bodily harm or property damage!



DANGER!

... indicates an immediately hazardous situation, which if not avoided, may result in death or serious injury.



WARNING!

... indicates a possibly hazardous situation, which if not avoided, may result in death or serious injury.



CAUTION!

... indicates a possibly hazardous situation, which if not avoided, may result in moderate or minor injury.



CAUTION!

... indicates a possibly hazardous situation, which if not avoided, may result in property damage.

Tips and recommendations:



NOTE!

... refers to useful tips and recommendations as well as information for efficient and trouble-free operation.

Festoon Systems for Steel Ropes Program 0210 / 0215

BAL0200-0004-E

2.2 Information on operating instructions

These operating instructions describe the safe and proper handling of the device. The safety instructions and the valid accident prevention regulations and the general regulations regarding accident prevention for the area of application are to be observed.

Before beginning any work on the components, operation and maintenance personnel must have read and understood the operating instructions and the “**Safety**” chapter, in particular.

2.3 Applicable documents

The operator must consider the following documents as supplements of the operating instructions (if applicable):

- Project-specific technical documentation
- Installation instructions
- Maintenance instructions
- Drawings
- Spare part lists
- Sketches

2.4 Limitation of liability

All data and information in these operating instructions has been compiled while taking the valid standards and regulations as well as the state-of-the art and our long years of experience and knowledge into consideration.

The manufacturer is in no way liable for damages resulting from:

- Non-observance of the operating instructions
- Improper use
- Subsequent changes and modifications to the system

The written and visual illustrations do not necessarily correspond to the scope of delivery. The illustrations do not correspond to a scale of 1:1.

The actual scope of delivery may vary from the data and information described here as well as the visual representations due to special models, the utilization of additional order options or recent technical changes. For more information, please contact the manufacturer.

All products are subject to technical modifications.

Festoon Systems for Steel Ropes Program 0210 / 0215

BAL0200-0004-E

2.5 Copyright

These operating instructions are to be considered as confidential. They are intended solely for persons working with the product. It is forbidden to pass on these operating instructions to third parties without the manufacturer's prior written consent!



NOTE!

This documentation is protected by copyright law. The rights established herein, including translation, reprinting, the use of figures, radio transmission, reproduction using photographic or similar methods or saving in electronic format remain reserved, even for partial use.

Wampfler AG reserves the right to make technical changes without informing the recipient of these documents/data.

Wampfler AG accepts no liability, in as much as this is legally permissible, for errors in this documentation or for damages that occur in connection with the delivery and use of the documentation.

2.6 Spare parts



WARNING!

Injury due to wrong spare parts!

Wrong or faulty spare parts can result in damages, malfunctions or complete failure as well as impair safety.

Therefore:

- use only original spare parts of the manufacturer!

The use of unauthorized spare parts renders null and void all warranty, service, compensation and liability claims against the manufacturer or his agents, dealers or representatives.

2.7 Disposal

Properly disassembled components are to be recycled if no return or disposal agreement has been made.

- Metal parts are to be scrapped
- Plastic elements are to be sent to the plastics recycling
- The other components are to be disposed of according to their material composition.

Festoon Systems for Steel Ropes Program 0210 / 0215

BAL0200-0004-E

3 Safety

This section gives insight into all of the important safety aspects for optimal protection of personnel as well as for safe and trouble-free operation.

The operator must observe the following standards and regulations when operating a festoon system:

98/37/EC	EC Machinery Directive
73/23/EEC 93/68/EEC	EC Low Voltage Directive
DIN EN ISO 12100	Machine Safety
IEC 60038	IEC standard voltages
IEC 60364	Electrical installations of buildings
IEC 60947	Low-voltage switchgear and controlgear
	Accident prevention regulations

3.1 Intended use

The machines are designed and constructed for the intended use only. The **festoon systems for C-rails** are only used for project-specific requirements.



WARNING!

Possible injury resulting from improper use!

Any application that deviates from or goes beyond the intended use of the machine can result in a hazardous situation.

Any claims against the manufacturer and/or its representatives for damages resulting from improper use of the products are excluded!

Non-intended use includes the following:

- Exceeding projected load capacities
- Exceeding projected speeds
- Excessive braking deceleration
- Use of inappropriate cables
- Changing atmospheric conditions (including a change to projected physical location)
- Bridging and/or deactivating electrical sensors or switches

Festoon Systems for Steel Ropes Program 0210 / 0215

BAL0200-0004-E

-
- The presence of projecting edges too close to the surrounding steel framework of the cable trolley.

Intended use is also considered to be the correct observance of the operating conditions as well as the data and instructions of these operating instructions.

3.2 Content of the operating instructions

Before beginning work, operation and maintenance personnel must have read and understood the operating instructions. This also applies if the aforementioned personnel has already worked with this type or similar machines, or has been trained by the manufacturer. Reading the content of the operating instructions is a precondition to protect personnel from hazards as well as to prevent errors and therefore to operate the product safely and in a trouble-free manner.

It is recommended that the operator have this acknowledgement of the content of the operating instructions confirmed by the personnel.

3.3 Changes and modifications to the machine

To avoid hazards and to ensure optimal performance, no changes or modifications may be made to the machines that have not been expressly approved by the manufacturer.

3.4 Operator responsibility

- These operating instructions must be stored on-site and always be kept readily available in a location near the festoon system.
- The festoon system may only be operated in good technical condition. Before initial commissioning, a visual inspection and predefined inspection is to be performed.
- The instructions in this manual are to be followed completely and precisely.
- In addition to the safety instructions and valid accident prevention regulations, the general regulations regarding accident prevention and general safety regulations as well as the valid environmental regulations are to be observed and adhered to.

Festoon Systems for Steel Ropes Program 0210 / 0215

BAL0200-0004-E

-
- The operator and personnel authorized by him are responsible for the trouble-free operation as well as for determination of responsibilities with regard to installation and maintenance of the products.

3.5 Requirements on the personnel



WARNING!

Injury due to insufficient qualifications!

Improper use can result in serious injury to person and property.

Therefore:

- Only have special activities performed by persons mentioned in the respective chapters of these operating instructions.

The following qualifications have been mentioned in these operating instructions for different areas of operation:

- **Instructed persons**

have been instructed by the operator about the tasks assigned to him/her and the possible hazards resulting from improper use.

- **Qualified specialists**

can assess the tasks assigned to them and recognize possible hazards based upon their specialized training, knowledge and experiences, as well as knowledge about applicable conditions.

The responsibilities for the work on and with the products (installation, maintenance) must be clearly defined and observed so that there is no unclear allocation of responsibilities and duties under the safety aspect.

Only persons capable of reliable work may work on or with the products. No work methods may be performed that affect the safety of persons, the environment or the described product.

Persons who are under the influence of drugs, alcohol or medication that affects the reaction time may not work on or with the products.

At the place of installation of the product, personnel are selected on the basis of the valid age and professional qualifications-related regulations.

The personnel are obligated to immediately report to the operator any changes occurring on the products which could have an effect on safety.

3.6 Personal protective equipment

When working on and with the products, personal protective equipment must be worn in order to minimize health hazard.



Protective work clothing

is close-fitting work clothing that has a low tearing strength with tight arms and no parts that protrude. It is mostly used as protection from getting caught by moving machine parts.

Do not wear any rings, chains or any other jewelry!



Safety shoes

used to protect from falling heavy parts and slipping on slippery floors.



Hard hat

to protect from falling and flying parts and materials.



Protective gloves

used to protect the skin from touching hazardous substances.



Protective goggles

for eye protection.

3.7 Hazards posed by product

The products have undergone a hazard analysis. The construction and design are based on the latest technology.

The products are safe when used properly. However, an element of risk still remains!

Festoon Systems for Steel Ropes Program 0210 / 0215

BAL0200-0004-E

The product operates using high voltage current:



WARNING!

Death due to electric shock!

The electrical current could cause serious bodily harm. Faulty insulation or individual components could lead to personal injury through electrical shock!

Causes:

- Touching or coming too close to uninsulated current-bearing parts
- Using uninsulated tools
- Current-bearing parts that are laid bare due to insulation failure
- Inadequate safety checks after maintenance work
- Use of improper fuses

Ways to protect yourself:

- Ensure that current to machines and system parts that are to undergo maintenance work is turned off and protected against reactivation.
- Check parts to ensure that they are free of current. Cover and isolate nearby live parts.
- Check electrical equipment regularly.
- Immediately replace loose or damaged cables or lines
- Always replace blown fuses with identical fuses
- Avoid touching live parts.
- Use insulated tools.

All errors must be analyzed before remedying the problem. Work on electrical systems or production equipment may only be performed by specialized electricians or persons under the supervision and direction of an electrician in accordance with electrical rules (qualified specialists).

Mechanical hazards:



WARNING!

Loss of consciousness and injury due to:

- crushing, shearing, cutting wrapping
- retracting, blunt collision, stabbing grinding
- slipping, stumbling, falling

Causes:

- Areas where danger of crushing, shearing and wrapping exists
- Breaking and bursting of parts.

Ways to protect yourself:

- Keep floors, devices and machines clean.
- Repair leaks.
- Observe the required safety distance.

Festoon Systems for Steel Ropes Program 0210 / 0215

BAL0200-0004-E

The festoon systems work at heights of more than 2 m:



WARNING!

Possible injury from falling parts

Avoid standing under the system, especially when it is running. Always wear a hardhat and safety shoes!

4 Construction

System sketches:



NOTE!

The following images are model illustrations. Deviations, depending on the type of construction, are possible. Please observe the respective project-specific documentation!

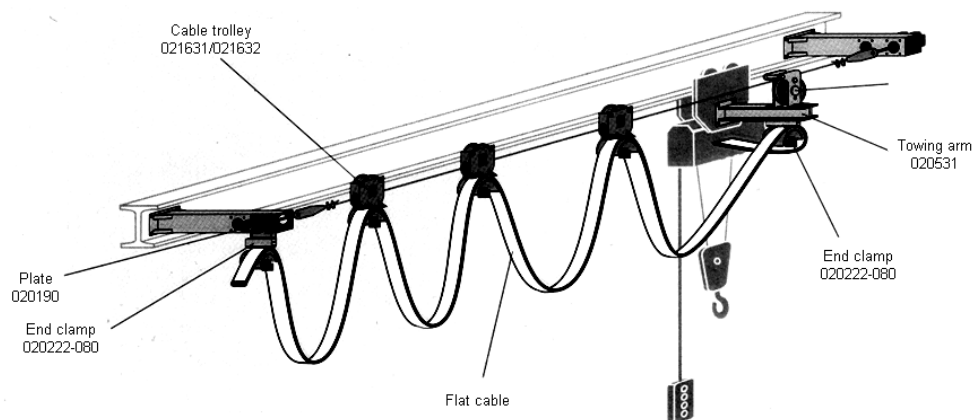

Fig. 1: Completely mounted energy supply system with flat cables

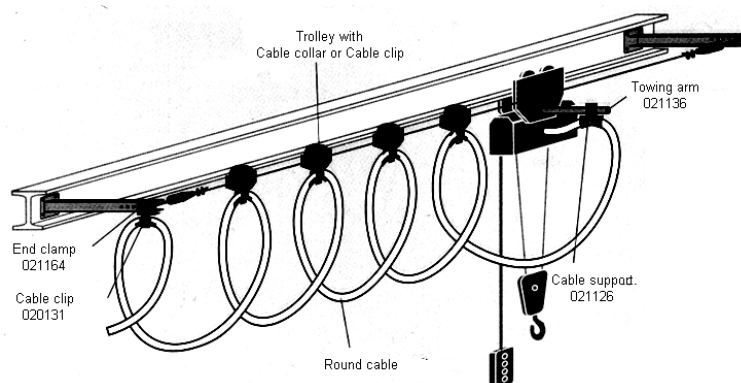

Fig. 2: Completely mounted energy supply system with round cables

5 Transport, packaging and storage

5.1 Safety instructions



WARNING!

Possible injury from falling objects!

During transport or loading and unloading there is a risk of possible injury from falling objects.

Therefore:

- Do not lift loads over people.

Unauthorized transport:



CAUTION!

Possible damage from unauthorized transport!

Transports performed by untrained personnel can result in substantial property damage.

Therefore:

- Unloading the delivery as well as internal transport may only be performed by trained personnel under the supervision of the manufacturer's employees.

Improper transport:



CAUTION!

Possible damage from improper transport!

Improper transports can result in substantial property damage.

Therefore:

- Act with care when unloading the delivery as well as internal transport and observe the symbols and the hazard information.

5.2 Transport inspection

Check the delivery for completeness and transport damage immediately upon receipt. If there is visible transport damage, do not accept the delivery or only accept under reserve. Take note of the scope of damage on the transport documents/ delivery note of the carrier. File a complaint.



NOTE!

Complain about hidden defects as soon as they are detected, since claims for compensation can only be made within the valid complaint period.

Festoon Systems for Steel Ropes Program 0210 / 0215

BAL0200-0004-E

5.3 Packaging

If no agreement regarding the return of the packaging has been made, the materials are to be separated according to type and size and are to be reused or recycled.



CAUTION!

Always dispose of packaging material in an environmentally friendly manner and according to the local disposal regulations. Hire a recycling company if necessary.



NOTE!

Good for the environment!
Packaging material is a valuable resource and can be reused, processed or recycled in many cases.

5.4 Storage

Store package pieces closed until installation and observe the stacking and storage identification.

Observe the storage conditions listed in the following table:

Climate zone	Storage location
Temperate (Europe, USA, Canada, China and Russia - except for tropical areas)	Covered and closed with constant temperature and humidity (5°C - 50°C, <50% relative humidity). No sudden temperature fluctuations, no uncontrolled ventilation; no aggressive vapors.
Tropical (Asia, Africa, Middle and South America, Australia, New Zealand - except for temperate areas)	Covered and closed with constant temperature and humidity (5°C - 50°C, <50% relative humidity). No sudden temperature fluctuations, no uncontrolled ventilation; no aggressive vapors. Protect against insect feeding.

Festoon Systems for Steel Ropes Program 0210 / 0215

BAL0200-0004-E

6 Installation

6.1 Safety instructions



WARNING!
Injury due to improper installation!

Improper installation can result in serious injury to person and property.
Therefore:

- The operation and maintenance personnel must have read and understood the operating instructions and in particular the guidelines on safety.
- Installation of the festoon system must be performed by sufficiently **qualified** and **trained** specialists.
- Protective gear for operation and maintenance personnel must be provided and used.
- The system operator or his/her representative is to supervise machine operation to ensure the safety of personnel when working on or with the system.

6.2 Steel rope fixation

6.2.1 General information

Usually there are two types of arrangement for the steel rope fixation:

- A Steel rope fixation with 2 end straining screws.
- B Steel rope fixation with end straining screw and deviating roller.

Rope loop h [% of the tensile length l]	Recommended design	
	Prog. 210	Prog. 215
0,63	Not recommended	B
0,80		B
1,00		B
1,25		B
1,60	A	A and B
2,00	A	A and B
2,50	A	A and B
3,20	A	A and B

Festoon Systems for Steel Ropes Program 0210 / 0215

BAL0200-0004-E

For applications, on which a constant rope loop must be guaranteed, even in case of variations in temperature, it is essential to always choose type B.

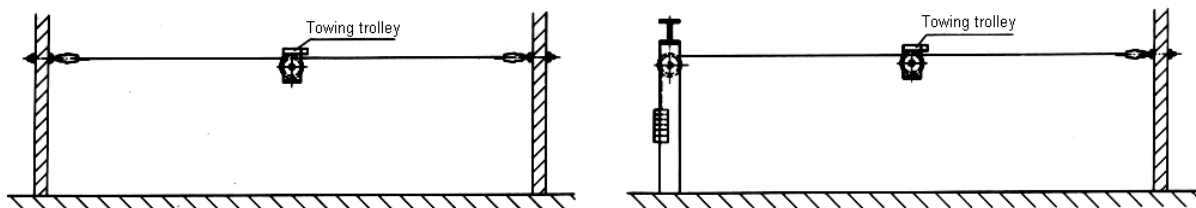

Fig. 3: Types of arrangement for the rope fixation

6.2.2 Steel rope fixation with 2 tensioning screws



CAUTION!
System damage from improper assembly!

- During the assembly of the rope system it is recommended to check the proper operation with one of the supplied cable trolleys.

Required tools:

i	NOTE!	
	Measuring tool Accuracy $\pm 0,5$ mm	
	Wrench	

Festoon Systems for Steel Ropes Program 0210 / 0215

BAL0200-0004-E

Screw both support arms to the existing construction. Then insert the steel rope into one of the opened tensioning screws and fix it with rope clips. Afterwards the premounted tensioning screw is fixed into the support arm. Now you place the towing trolley and the cable trolleys onto the steel rope. The loose end of the steel rope is now assembled with the remaining tensioning screw, placed into the support arm and secured against slipping out. Now introduce the towing arm into the towing trolley and screw it to the mobile consumer. Install the end clamp on the feeding side and begin to lay on the cables. As soon as the cables have been clamped in the festoon, tension the rope by tightening the nuts at the tensioning screws.

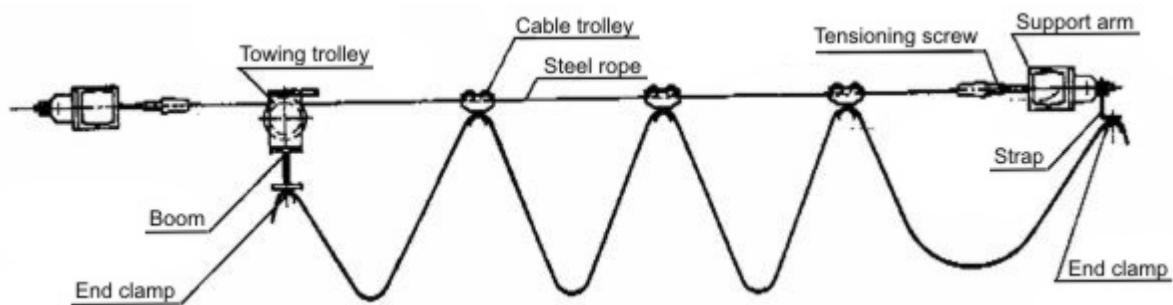

Fig. 4: Example of a complete energy supply system with 2 tensioning screws

Festoon Systems for Steel Ropes Program 0210 / 0215

BAL0200-0004-E

6.2.3 Steel rope fixing with tensioning screws, roller trestle and counterweight



CAUTION!
System damage from improper assembly!

- During the assembly of the rope system it is recommended to check the proper operation by means of one of the supplied cable trolleys.

Required tools:

i	NOTE!	
	Measuring tool Accuracy $\pm 0,5$ mm	
	Wrench	

The steel rope is introduced into the opened tensioning screw and fixed by rope clips. After that install the premounted tensioning screw into the support arm and tighten it. The towing trolley and the cable trolleys are now placed on the steel rope. The loose end of the steel rope is now led over the deviating roller and tensioned with the counterweight. Now introduce the towing arm into the towing trolley and screw it to the mobile consumer. Install the end clamp on the feeding side and start to lay on the cables.

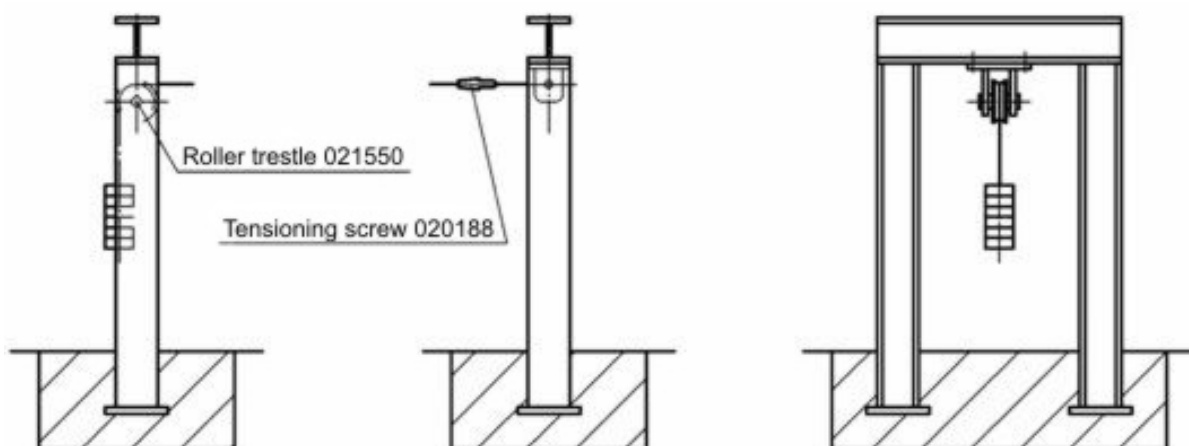

Fig. 5: Example of a bracing on two mats with counterweight

Festoon Systems for Steel Ropes Program 0210 / 0215

BAL0200-0004-E

6.3 Assembly of the cables trolleys 021111, 021112, 021115 and 021116



CAUTION!
System damage from improper assembly!

Required tools:

i	NOTE!	
	Screwdriver	

The cable trolleys of this standard have been designed in such a way that they can be mounted if the rope or wire is under tension. Remove the screw and the roller first and then force the cable trolley apart (figure a). now move the cable trolley upwards, press it together laterally and install the roller (figure b). Finally fix the screw (figure c). On the cable trolleys 021111 and 021112 hook in the cable collars 020111/020114 or the connecting ear 020113 first and finally press the hook together.

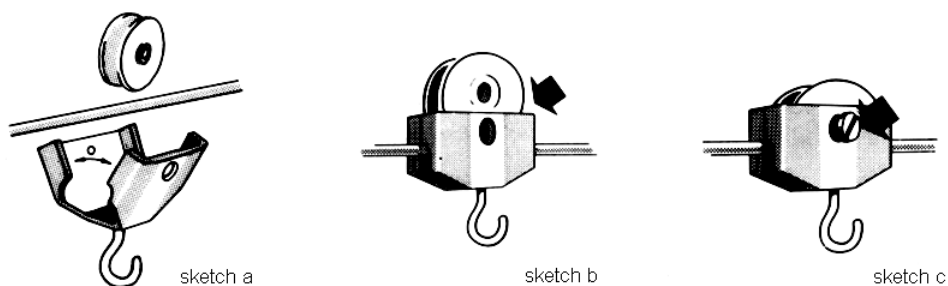

Fig. 6: Assembly of the cable trolleys

Festoon Systems for Steel Ropes Program 0210 / 0215

BAL0200-0004-E

6.4 Laying of cables



CAUTION!
System damage from improper assembly!
Use only appropriate flexible!

6.4.1 Laying of round cables



CAUTION!
Damage of the festoon system due to improper assembly!
Improper arrangement of the cables within the cable package and the loop will cause damage of the cables and the cable trolley technique!

Depending on the type of cable trolley the installation of the round cables is made by cable collars 020111 or cable clips 020131.

Optionally you can mount one, two or three different or equal cable clips one below the other. It must be observed that, if different cable clips are used, the larger one must be fixed on top.

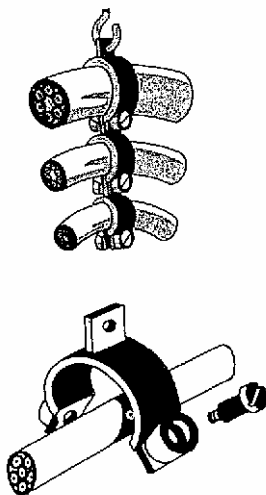

Fig. 7: Cable collar 020111

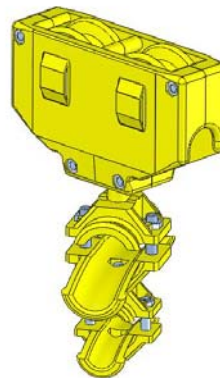

Fig. 8: Cable trolley with cable clips 020131

Festoon Systems for Steel Ropes Program 0210 / 0215

BAL0200-0004-E

6.4.2 Arrangement of flat cables



CAUTION!

System damage from improper assembly!

Improper arrangement of cables in the cable package and in loops can damage the cables and the festoon system.

The projected cable setup for the festoon system is to be maintained. The following rules are recommended:

- Place the cable package towards the middle of the track beam so that the torque is in balance.
- When using layered flat cables, give each layer of cables slightly less slack than the layer below.
- Cables with large copper diameters are to be placed symmetrically to the center of the trolley and at the top of the cable package.
- When using flag cable clamps, only the uppermost cables are clamped. The other cables must be freely movable in the flat cable clamp window.
- Tighten the screws of the clamping bar by hand. The cables must be sufficiently clamped without causing damage to them. The clamping force check is necessary when commissioning the system and must be inspected on a regular basis.

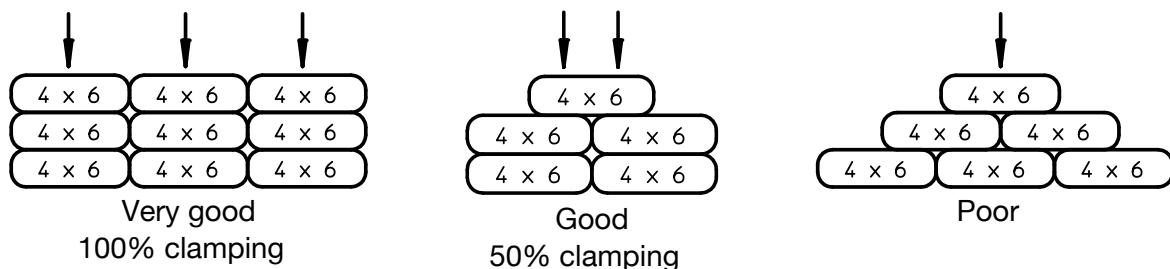

Fig. 9: Arrangement of flat cables

Thicker cables (such as 4 x 50) are to be placed at the top of the cable package. This allows for good heat dissipation and tight clamping of smaller cables. Traction forces that occur during movement can be taken up by these cables.

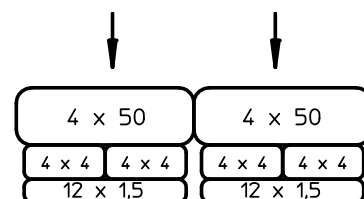

Fig. 10: Cable arrangement

Festoon Systems for Steel Ropes Program 0210 / 0215

BAL0200-0004-E



6.5 Flat cable clamps



CAUTION!
System damage from improper assembly!

- Improper positioning of the flat cable clamps can lead to damage of the cables and festoon system.
- An improper fixation and arrangement of the cables in the flat cable clamp will cause damage of the cables and the cable trolley technique.
- Clamp the uppermost cables in the flat cable clamp. The other cables must be freely movable in the flat cable clamp window.

Required tools:

i	NOTE!	
	Hexagon wrench (Allen wrench) WS 5	
	Lubricant for screws Recommendation: Klüber 46 MR 401	

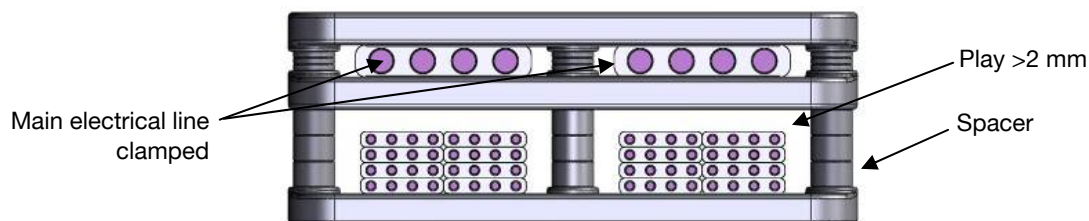

Fig. 11: Flat cable clamp

The arrangement of the spacers allows for the height of the flat cable clamp to be adapted to the cable package.

The window for the control cable is to be adjusted so that the cables of the block have enough play (>5 mm) in the window.

The screws are to be lubricated (recommendation: Klüber 46 MR 401).

Festoon Systems for Steel Ropes Program 0210 / 0215

BAL0200-0004-E

6.6 Cable trolleys with plastic support and split nuts



CAUTION!

System damage from improper assembly!

- Nominal clamping torque for the plastic split nuts: 1.5 Nm
- Max. permissible clamping torque: 2 Nm

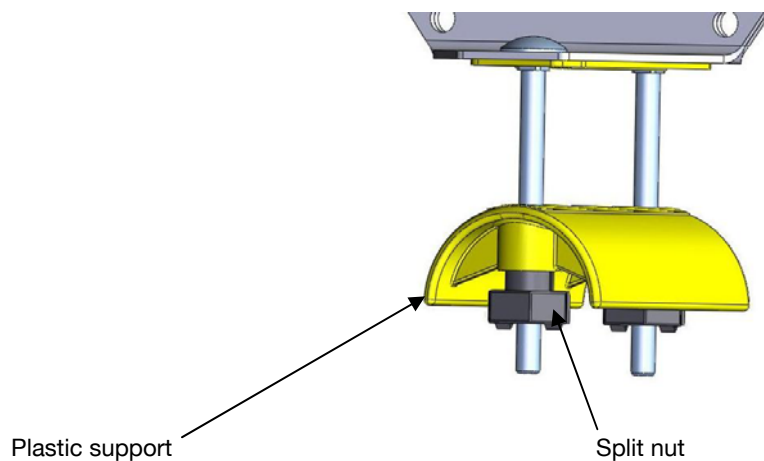

Fig. 12: Cable trolley with plastic support and split nuts

Required tools:

i	NOTE!	
	Torque key	

7 Commissioning the festoon system



WARNING!

System damage from improper mounting or construction of the festoon system

- Before commissioning, perform a visual check. The predefined inspection procedure has to be performed.
- Any procedures that could threaten safety are to be avoided.
- The system should only be operated with functional protective gear and safety devices.
- Notify the responsible party immediately in case of damage to the festoon.
- Protect the festoon system from accidental or unauthorized operation.
- It is forbidden to enter the operating area of the festoon system.

The festoon system is commissioned together with the system operator and is documented. All necessary personnel for commissioning including crane operators, electricians and installation technicians are to be provided by the system operator for the course of commissioning. Free access to the system must be provided. After successful commissioning, Wampfler AG will receive a final handover document that is authorized by the system operator indicating that the system meets all requirements. The commissioning is to be performed based on the “Commissioning Checklist” document.

7.1 Inspections on deactivated system



WARNING!

System damage from wrong action.

- Protect the festoon system from inadvertent activation.
- Safety devices that were removed during inspection of the resting system must be immediately remounted and checked after completion of work.
- Check measuring tools used after clean up/ collection and inventory.

The following points are to be checked prior to commissioning the system:

- The track beam of the festoon system corresponds to the project-specific technical documentation.
- The storage length of the festoon system corresponds to the project-specific technical documentation.
- There are no height differences and that all buffers meet centrally.

Festoon Systems for Steel Ropes Program 0210 / 0215

BAL0200-0004-E

-
- End clamp is mounted.
 - All screws have a sufficient length and are secured. The projecting ends of the screws are visible (at least 2 thread projection).
 - All screw connections are to be secured against loosening.
 - Cables are to be arranged according to specifications in the cable arrangement recommendation (see project-specific technical documentation).
 - Loop lengths of the cables correspond to the specifications of the project-specific technical documentation. The permissible length deviation is ± 50 mm.
 - Cables are arranged free of twists
 - Cables show no damage caused by transport or assembly.
 - Cables are mounted on the supports in such a way, that the cable trolley is running horizontally on the steel rope (observe torque balance of the cables).
 - Cable clamps firmly tightened so that cables cannot be pulled out manually, but still with enough play that the cables are also not crushed.
 - Cable ends (installation lengths) are arranged with sufficient strain relief and the right length to the end or towing side.
 - Cable clamps (round and flat cable clamps) are mounted in the loops corresponding to the project-specific documentation (system sketch) with the necessary displacement. Special component parts such as spacers, additional clamp pieces and guide rings are to be mounted according to the project-specific technical documentation.
 - Checking for collision free driveway of the festoon system. No catching, intertwining of the cables, towing ropes and shock cords.

7.2 Inspections on running systems



WARNING!

System damage from wrong action!

- Any procedures that could threaten safety are to be avoided.
- The system should only be commissioned with functional protective gear and safety devices.
- It is forbidden to enter the operating area of the festoon system.

Execution:

- Inspections on running systems with 10% running speed: Forward direction from the trolley storage / end clamp side towards the towing side until the cable tow is completely wound up. Backward direction from the towing side towards the trolley storage / end clamp side up to the end position.

Festoon Systems for Steel Ropes Program 0210 / 0215

BAL0200-0004-E

The following items are to be checked:

- Horizontal alignment gap between the cable trolley and the crane construction is wide enough that no collision can take place with cable trolleys or their components.
- Check of the loop lengths at the maximum pulled out cable tow corresponds to the project-specific technical documentation.

If no defects are detected, then the check is repeated at 50% and 100% running speed. The testing time in nominal operation is 30 minutes.

8 Operation



WARNING! **Bodily harm!**

- Any procedures that could threaten safety are to be avoided.
- The system should only be operated with functional protective gear and safety devices.
- It is forbidden to enter the operating area of the festoon system.

The system is to be checked for changes in running noise and irregularities during operation.

If irregularities are determined during operation, then the system is to be stopped immediately. The cause of the fault is to be determined using the fault table (see chapter 10).

The fault table includes the causes for the disturbance as well as the recommendations for their remedy. If the cause cannot be determined or if there is no way to repair the system with the company's resources, then we recommend that you request a service technician from our customer service.

9 Faults - causes and solution



WARNING!

Injury due to insufficient qualifications!

Improper use can result in serious injury to person and property.

Therefore:

- Elimination of faults may only be performed by qualified specialists.

Störungen	Ursache	Beseitigung
Roller function impaired	Overstress Wear	Exchange roller
Noticeable mechanical strain of the components (bending, tear, wear)	Breakdown*	Exchange the corresponding component

* If injury to person and property can occur during breakdowns then Wampfler AG is to be immediately informed.

Festoon Systems for Steel Ropes Program 0210 / 0215

BAL0200-0004-E

10 Maintenance

In order to retain the warranty rights and to avoid damage, the system operator is responsible for performing the following maintenance tasks. Inspection, service and repair are to be performed and documented by trained and qualified specialists.



WARNING!
Bodily harm!

- The intervals indicated for maintenance are dependent for the most part on operational conditions of the festoon system. Therefore only mean values can be indicated here.

The following tasks fall under the category “Maintenance”:

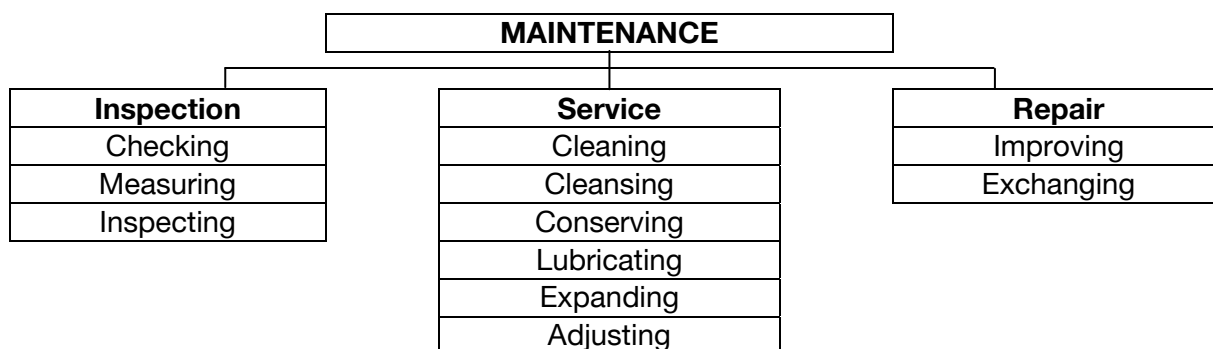

Festoon Systems for Steel Ropes Program 0210 / 0215

BAL0200-0004-E

10.1 Inspection

10.1.1 Inspection on deactivated system



WARNING!

System damage from wrong action.

- Protect the festoon system from inadvertent activation.
- Safety devices that were removed during inspection of the resting system must be immediately remounted and checked after completion of work.
- Check measuring tools used after clean up/ collection and inventory.
- Before approaching systems with damping devices, these must be released first.

Inspection measures

Interval	Component	Measure	Description
Every 14 days: 3 and 4 shift operation, at the latest after 300 operational hours Every 30 days: 2 shift operation, at the latest after 300 operational hours	Rollers	Visual inspection	- for proper condition
	Center plate		- for proper function
	Cable supports		- for proper mobility
	Fasteners		- for firm seating
	Cables		- for deformations
	Cable clamps		- for wear
	Fixed installation length		- for damages
	Installation connections		- for dirt
	Towing devices		- for corrosion
	Steel ropes		

Festoon Systems for Steel Ropes Program 0210 / 0215

BAL0200-0004-E

10.1.2 Inspection of towing ropes and criteria for replacement



WARNING!

Injury and damage to the festoon system!

- Towing ropes must be inspected at regular intervals. The inspections must be performed at least every 12 months.

If any defects have occurred the steel ropes must be immediately withdrawn from further use. They must be discarded (replaced). A steel rope must be discarded if one or several of the following criteria have been fulfilled:

1. Wire breakage
2. Structural changes
3. Corrosion
4. Abrasion

The following cable deformations are grounds for replacement:

- Corkscrew-like deformation: A steel rope must be discarded if a corkscrew-like deformation has reached a wave height of 1/3 of the rope diameter.
- Fraying: Replace the cable if it starts to fray.
- Loop formation: Replace the cable if loop formation has led to significant changes in the cable structure.
- Loosening: Replace if wires are loosened due to rust or abrasion.
- Node formation: Replace if nodes- points where the cable is widened- form in the steel cable.
- Constrictions: Replace in case of severe constrictions in the cable.
- Curl-like deformation: discard if the steel rope has been subject to consistent deformations, e.g. because it has been drawn over an edge.
- Kinks: Replace if kinks form after tension is applied to cable loops.
- Bends: discard if bends have occurred on the steel rope due to exterior influences.

Festoon Systems for Steel Ropes Program 0210 / 0215

BAL0200-0004-E

10.1.3 Inspection on moving system



WARNING!

System damage from wrong action!

- Any procedures that could threaten safety are to be avoided.
- The system should only be commissioned with functional protective gear and safety devices.
- It is forbidden to enter the operating area of the festoon system.

Inspections measures

Interval	Component	Measure	Description
Every 14 days: 3 and 4 shift operation, at the latest after 300 operational Every 30 days: 2 shift operation, at the latest after 300 operational hours	Rollers	Function test	Visible wear, damage.
	Cable trolley		Proper running-in and running out of the cable trolleys in the storage area.
	Towing device		For reliable operation of the towing device based on the required horizontal and vertical balancing movements.
	End clamp		For functionality of the damping device, especially when the system is in the storage.
	Steel ropes and installation		Steel ropes and the complete installation, if degree of pollution and corrosion affect the functionality

Should problems be identified during inspection, the service work shown in chapter 10.2 should be performed.

10.2 Service



WARNING!

System damage from wrong action!

- Turn off power supply and ensure that no inadvertent activation is possible.
- When installation tasks are carried out above eye level, use proper climbing aids and working platforms.
- Do not use machine components as climbing aids.
- Ensure that exhaust, collection and disposal of process materials is done in a safe and environmentally-friendly manner.
- Safety devices that were removed for installation, service or repair must be immediately remounted and inspected after work is completed.
- Observe the inspection and maintenance intervals described in the maintenance instructions.
- Ensure that sufficient space for maintenance work is available.
- Ensure that the festoon system is not inadvertently activated during maintenance work.
- Ensure that detached parts do not fall.
- Screw joints that are disconnected during maintenance work are to be reattached and secured as instructed.
- Fasteners and seals that cannot be reused are to be replaced (such as self-locking nuts, disks, splints, O-rings, glued or microencapsulated screws).
- Lubrication points that are cleaned or wiped during maintenance and repair work must be re-lubricated as instructed.
- After finishing work, collect all tools and materials and check that all are present.
- Disassembled parts and components that were exchanged are to be collected, stored in a safe place, recycled or sent back.
- Before approaching systems with damping devices, these must be released.

Operating Instructions



Festoon Systems for Steel Ropes Program 0210 / 0215

BAL0200-0004-E

Service tasks

Interval	Component	Task	Description
Every 14 days: 3 and 4 shift operation, at the latest after 300 operational hours Every 30-days: 2 shift operation, at the latest after 300 operational hours	Roller mounting	Maintenance measures	Checking of function respectively damage. Possible replacement of cable trolleys
	Cable mounting		Tighten all Fasteners on clamping bars and cable clamps.
	Towing device		Tighten all Fasteners
	Damping device		Replace shock cords if necessary.
Every 3 month	Steel ropes		Tighten mounting screws. Lubricate shackles.
	End Clamp		Tighten mounting screws. Possible replacement of wear parts
Yearly, (depending on external influences)	Surface/ corrosion protection Corrosion protective coating	Improve/ replace	Refinish hot-dip galvanized surfaces with zinc coating. Refinish lacquered surfaces.

Festoon Systems for Steel Ropes Program 0210 / 0215

BAL0200-0004-E

10.3 Repeat inspections



WARNING!

Injury and damage to the festoon system!

Devices and systems are to be periodically inspected by an expert. In general, visual and functional checks are to be performed. The condition of components with regard to damage, wear, corrosion or other damage is to be determined. Generally speaking, the completeness and functionality of the safety equipment is evaluated. To better evaluate the wear and tear of parts, disassembly may be required.

All regular inspections are to be performed by the operator

Every operator is to record all inspection, service and maintenance tasks in a machine book in an orderly manner. This is to be confirmed by a technical expert. In case of inaccurate or missing entries, the warranty is rendered null and void.

10.4 Repair

Request a customer service technician from Wampfler AG for all repairs.

If qualified service technicians from the system operator perform the repairs themselves, all information contained in these operating instructions must be observed.

Wampfler AG accepts no liability or responsibility for damages and production faults that result from failure to follow these operating instructions.

For maintenance and repair, only use

- suitable tools in good working order
- original spare parts from Wampfler AG or spare parts that have been explicitly approved by Wampfler AG

Festoon Systems for Steel Ropes Program 0210 / 0215

BAL0200-0004-E

11 Spare parts



WARNING!

Injury due to wrong spare parts!

The installation and/or use of unauthorized spare parts or accessories can have a negative impact on the structural properties of the festoon system and therefore affect active and passive safety. No liability is accepted or warranty given for damages that occur from the use of unauthorized spare parts and accessories.



NOTE!

Keeping a stock of the most essential spare and wear parts at the place of installation ensures constant operational readiness of the system.

For spare part orders, please indicate the following data:

- Part no. (see spare part list project documentation)
- Description
- Piece number
- Desired mode of shipping (postal, freight, sea, air, express)
- Shipping address

Festoon Systems for Steel Ropes Program 0210 / 0215

BAL0200-0004-E

12 Product observations

We strive to observe our products after delivery in order to further improve them and better meet your needs.

Please use the form on the following pages to communicate your experiences and issues with us that could be of interest for our improvement process.

Thank you very much for your help.

Please fax the filled out form to: ++49 7621 662 284

For example:

- changed configuration data
- experiences with the festoon system
- recurrent errors
- difficulties with documentation

Your contact data:

Company:	Cust. No.:
Department	
Contact Person	
Address	Zip code
PO Box	Zip code
City	
Phone	Fax
Email	

Ihre Erfahrungen und Beobachtungen:

Operating Instructions



Festoon Systems for Steel Ropes Program 0210 / 0215

BAL0200-0004-E

13 Appendix

13.1 Final handover document

Customer:	Customer no.:	
	Purchase no.:	
	Contractor:	
	Confirmation no.:	
Installation Site	Project designation:	
	Address:	
	Post code:	City:
	Contact person / Phone no.:	Meeting point:
Start of installation (on-site):		End of installation (on-site):
Needed installation time (in h):		Needed travel time (in h):

The installation of above mentioned project has been ended today through the Wampfler AG, Germany. From today, the risk is given over to the contractor.

The acceptance has been confirmed on the customer-specific "taking-over" report. yes

Enclosure:

Maintenance instructions have been handed over: yes

CE label is affixed: yes

Complaint of the customer:

Complaint of the supplier:

Following works, included in the order, could not be achieved:

Installation supervisor (Wampfler AG)		Installation supervisor (customer)	
Name:		Name:	
Date:	Signature:	Date:	Signature: